

Synco™ 200

## Universal Controllers

RLU2...

- 
- With programmed standard applications
  - Freely programmable controller, for optimum adaptation to the relevant type of plant
  - P-, PI, or PID mode
  - Menu-driven operation

### Use

---

For use on basic to complex ventilation, air conditioning and chilled water plant. The universal controllers are designed to handle the following controlled variables: Temperature, relative/absolute humidity, pressure/differential pressure, airflow, indoor air quality and enthalpy.

## Functions

---

### Operating modes

- Selection of operating mode via status inputs: Comfort, Economy, Protection
- Display of current operating mode (Comfort, Economy, Protection)

### Setpoints

- With each sequence controller: Individually adjustable heating and cooling setpoints (or maximum and minimum setpoints) for the Comfort and Economy modes
- Predefined room temperature setpoint with room unit or setpoint readjuster (passive)
- With each sequence controller: Predefined setpoint with remote setpoint adjuster (active or passive)
- Room temperature setpoint with summer and/or winter compensation
- With each sequence controller: Setpoint shift depending on sensor signal, selectable start and end points

### Universal inputs

Universal inputs for:

- Passive or active analog input signals of various measured values (°C, %, ---)
- Digital input signals (potential-free contacts)

### Control functions

- Universal controller (sequence controller) for 2 heating sequences (reverse acting) and 2 cooling sequences (direct acting), can be used as a controller providing P-, PI or PID mode, or as a differential controller
- Controller can be configured as a room/supply air temperature cascade controller with limitation of the supply air temperature
- Each sequence can be assigned modulating control (modulating output, step switch, mixed air damper/heat recovery equipment) and a pump. 2 sequences can act on the same modulating control (e.g. priority cooling/dehumidification)
- General limitation (minimum/maximum with PI mode per sequence controller, either as absolute limitation, e.g. for the supply air temperature or supply air humidity), or as relative temperature limitation (e.g. maximum limitation of the room/supply air temperature differential). Limitation acts on all sequences. Minimum limitation can be set to a lower setpoint while cooling is on (e.g. cooling with DX cooler battery)
- Sequence limitation with PI mode per universal controller, can be defined as minimum or maximum limitation. Limitation acts on a single sequence (e.g. heat recovery anti-icing protection or maximum limitation of the heating coil's return temperature)
- The mixed air temperature controller controls the mixed air temperature via the air dampers
- Locking of individual sequences
- Digital input (heating limit switch, from a heating controller) for changing the control strategy (room-supply air temperature cascade control), configurable

## Switching and supervisory functions

- 2-stage frost protection (modulating/2-position) or frost protection thermostat (heating sequences delivering 100 % output, fault relay for switching off the fans) (with RLU220 only indication)
- Control of pumps, constantly ON at low outside temperatures, ON according to load sequence controller (not with RLU220); periodic activation of pump (pump kick)
- Control of an analog output (not with RLU202). Configurable external presetting (controller used as a pure signal converter). Minimum and maximum position, invertible.  
Minimum limitation at low outside temperatures
- Control of mixed air dampers or heat recovery equipment with maximum economy changeover (not with RLU202), startup function at low outside temperatures
- Control of a multistage aggregate with a step switch, with a maximum of 6 steps and a modulating output.  
The switching on/off points of each step can be adjusted. Adjustable delay times. Configurable external presetting (controller used as a pure step switch). Modulating output with minimum and maximum position, invertible (only with RLU236)
- Control of a multistage aggregate with a step switch, with a maximum of 2 steps and a modulating output.  
Functions as described above (not with RLU220)
- Control of a linear multistage aggregate with a step switch, with a maximum of 6 steps and a modulating output.  
Fixed assignment of switching on/off points to the load. Adjustable delay times and priority changeover. Configurable external presetting (controller used as a pure step switch). Modulating output for load assignment to the steps, with minimum and maximum position, invertible (only with RLU232 and RLU236)
- Control of a binary multistage aggregate with a step switch, with a maximum of 4 relays for 15 steps and a modulating output.  
Fixed switching on/off points with binary switching logic. Adjustable delay times. Configurable external presetting (controller used as a pure step switch). Modulating output for load assignment to the steps, with minimum and maximum position, invertible (only with RLU232 and RLU236)
- Control of a modulating 3-position actuator. Configurable presetting (controller used as a pure analog/3-position converter) (only with RLU202 and RLU222)
- Delivery of a passive measuring signal as an active signal for use by other controllers

## Type summary

<i>Type reference</i>	<i>Universal inputs</i>	<i>Digital inputs</i>	<i>Positioning outputs</i>	<i>Switching outputs</i>	<i>Number of control loops</i>
<b>RLU202</b>	4	1	0	2	1
<b>RLU220</b>	4	1	2	0	1
<b>RLU222</b>	4	1	2	2	2
<b>RLU232</b>	5	2	3	2	2
<b>RLU236</b>	5	2	3	6	2

## Accessories

<i>Name</i>	<i>Type reference</i>
Mounting frame for flush panel mounting (consisting of 1 small frame, 1 large frame, 2 hexagonal spacers, 4 fixing screws, Mounting Instructions)	<b>ARG62.201</b>

## Ordering

---

When ordering, please give name and type reference of the controller, e.g.:  
Universal controller **RLU236**.  
The products listed under "Accessories" must be ordered as separate items.

## Equipment combinations

---

For equipment combinations, refer to the Basic Documentation P3101 or to the document covering the selected application.

## Product documentation

---

<i>Document type</i>	<i>Document number</i>
Basic Documentation: Universal Controllers RLU2...	<b>CE1P3101en</b>
Instructions Set (mounting, commissioning, operation)	<b>74 319 0424 0</b>
Declaration of Conformity (CE): RLU2...	<b>CE1T3101xx</b>
Environmental Declaration: RLU202, RLU220, RLU222	<b>CE1E3101en01</b>
Environmental Declaration: RLU232 and RLU236	<b>CE1E3101en02</b>

## Technical design

---

Each controller offers up to 45 ready programmed applications. When commissioning a plant, the relevant basic type must be entered. All associated functions, terminal assignments, settings and displays will then automatically be activated and parameters that are not required will be deactivated.

In addition, each type of universal controller has 2 empty applications loaded:

- 1 for basic type A (ventilation controller)
- 1 for basic type U (universal controller)

With the help of the built-in operation or the OCI700.1 service tool, the controller affords:

- Activation of a programmed application (refer to "Programmed standard applications")
- Modification of a programmed application
- Free configuration of applications
- Optimization of the controller settings

For operating actions of the functions, refer to the Basic Documentation.

The universal controller consists of terminal base and controller insert with built-in operation.

The terminal base can be fitted to a DIN mounting rail or is screwed directly on a flat surface. It consists of a plastic housing with 2 terminal levels.

The controller insert engages in the terminal base. It consists of a plastic housing which accommodates the printed circuit boards.

Controller operation is fully integrated.

### Operating, display and connecting elements

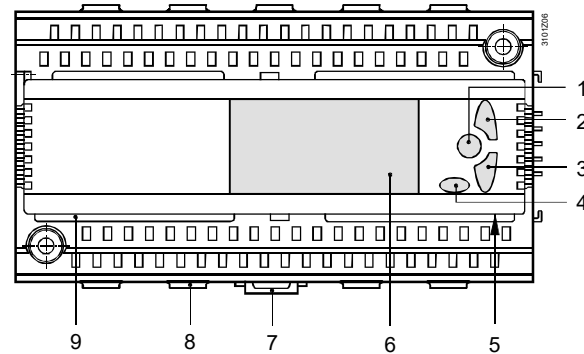

### Legend

- |   |   |
|---|---|
| 1 | OK button for confirming the selected menu line or the value entered              |
| 2 | Navigation button, upward (+) for selecting the menu line or changing the value   |
| 3 | Navigation button, downward (-) for selecting the menu line or changing the value |
| 4 | ESC button for returning to the previous menu or for rejecting the value entered  |
| 5 | Connection facility for the service tool (RJ45 connector)                         |
| 6 | Display   |
| 7 | Catch for fitting the controller to a top hat rail                                |
| 8 | Fixing facility for a cable tie (cable strain relief)                             |
| 9 | Rest for the terminal cover   |

### Engineering notes



- The controller operates on AC 24 V. Operating voltage must conform to the requirements of SELV/PELV (safety extra low-voltage)
- The transformers used must be safety isolating transformers featuring double insulation to EN 60 742 or EN 61 558-2-6; they must be suited for 100 % duty
- Fuses, switches, wiring and earthing must be in compliance with local regulations
- Sensor wires should not be run parallel to mains carrying wires that power fans, actuators, pumps, etc.
- It is recommended to use the standard applications provided. Specific plant situations may require certain adaptations however

## Mounting and installation notes

---

- Controllers and extension modules are designed for:
  - Mounting in a standard cabinet to DIN 43 880
  - Wall mounting on an existing top hat rail (to EN 60715-TH35-7.5)
  - Wall mounting with 2 fixing screws
  - Flush panel mounting with ARG62.201 mounting frame
- Not permitted are wet or damp spaces. The permissible environmental conditions must be observed
- Disconnect the system from the power supply prior to mounting the controller
- **The controller insert must not be removed from the terminal base!**
- All connection terminals for protective extra low-voltage are located in the upper half of the unit, those for mains voltage at the bottom
- Each terminal (spring cage terminal) can accommodate only 1 solid wire or 1 stranded wire. For making the connections, the cables must be stripped for 7 to 8 mm. To introduce the cables into the spring cage terminals and to remove them, a screw driver size 1 is required. Cable strain relief can be provided with the help of the fixing facility for cable ties
- The controller is supplied complete with Installation and Operating Instructions

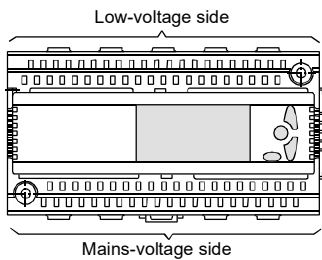

## Commissioning notes

---

- The configuration and parameters of the standard applications offered by the controller can be changed any time by service staff who have been trained by HVAC Products and who have the required access rights, either locally or online/offline with the service tool
- During the commissioning process, the application is deactivated and the outputs are in a defined off state
- On completion of the configuration, the controller automatically makes a new start
- When leaving the commissioning pages, the peripheral devices connected to the universal inputs (including the extension modules) are automatically tested and identified. If a peripheral device is missing, a fault status message will be delivered
- If adaptations to specific plants are required, they must be recorded and the documentation kept inside the control panel
- For the procedure to be followed when starting up the plant for the first time, refer to the Installation Instructions

## Disposal notes

---



The device is considered an electronic device for disposal in accordance with European Directive and may not be disposed of as domestic waste.

- Use only designated channels for disposing the devices.
- Comply with all local and currently applicable laws and regulations.

## Warranty

---

Technical data on specific applications are valid only together with Siemens products listed under "Equipment combinations". Siemens rejects any and all warranties in the event that third-party products are used.

## Technical data

<b>Power supply (G, G0)</b>	Rated voltage	AC 24 V $\pm$ 20 % (SELV)
	Requirements for external safety isolating transformer to	EN 60 742 / EN 61 558-2-6, min. 10 VA, max. 320 VA
	Frequency	50/60 Hz
	Power consumption	
	RLU202, RLU220, RLU222	5 VA
RLU232, RLU236	6 VA	
Supply line fusing	Fuse slow max. 10 A or Circuit breaker max. 13 A Characteristic B, C, D according to EN 60898 or Power source with current limitation of max. 10 A	
<b>Universal inputs</b>	Number	refer to "Type summary"
Measured value inputs (X...)	Sensors	
	Passive	LG-Ni 1000, T1, Pt 1000 2x LG-Ni 1000 (averaging)
	Active	DC 0...10 V
	Signal sources	
Passive	0...1000 $\Omega$ / 1000...1175 $\Omega$	
Active	DC 0...10 V	
Digital inputs (X..., D...)	Contact sensing	
	Voltage	DC 15 V
	Current	5 mA
	Requirements for status contacts	
	Signal coupling	potential-free
	Type of contact	maintained contacts
Insulating strength against mains potential	AC 3750 V to EN 60 730	
Perm. resistance		
Contacts closed	max. 200 $\Omega$	
Contacts open	min. 50 k $\Omega$	
<b>Outputs</b>	Number of positioning and switching outputs	refer to "Type summary"
Positioning outputs Y...	Output voltage	DC 0...10 V
	Output current	$\pm$ 1 mA
	Max. load	continuous short-circuit
	 Switching outputs AC 230 V (Q1x...Q6x)	External supply line fusing
Non-renewable fuse (slow)	max. 10 A	
Automatic line cutout	max. 13 A	
Release characteristic	B, C, D to EN 60 898	
Cable length	max. 300 m	
Relay contacts		
Switching voltage	max. AC 265 V min. AC 19 V	
AC current	max. 4 A ohm., 3 A ind. (cos $\varphi$ = 0.6) min. 5 mA	
At 250 V	min. 20 mA	
At 19 V	min. 20 mA	
Switch-on current	max. 10 A (1 s)	
Contact life at AC 250 V	guide values:	
At 0.1 A res.	2 x 10 <sup>7</sup> cycles	
At 0.5 A res.	4 x 10 <sup>6</sup> cycles (NO)	

	At 4 A res.	2 x 10 <sup>6</sup> cycles (changeover) 3 x 10 <sup>5</sup> cycles (NO) 1 x 10 <sup>5</sup> cycles (changeover)
	Red. factor at ind. (cos φ = 0.6)	0.85
	<b>Insulating strength</b>	
	Between relay contacts and system electronics (reinforced insulation)	AC 3750 V, to EN 60 730-1
	Between neighboring relay contacts (operational insulation)	
	Q1↔Q2; Q3↔Q4; Q5↔Q6	AC 1250 V, to EN 60 730-1
	Between relay groups (reinforced insulation) (Q1, Q2) ↔ (Q3, Q4) ↔ (Q5, Q6)	AC 3750 V, to EN 60 730-1
Power supply external devices (G1)	Voltage	AC 24 V
	Current	max. 4 A
<b>Interfaces</b>	Service tool connection facility	RJ45 connector
<b>Perm. cable lengths</b>	For passive measuring and positioning signals	(measuring errors can be corrected)
	Type of signal	
	LG-Ni 1000, T1	max. 300 m
	Pt 1000	max. 300 m
	0...1000 Ω	max. 300 m
	1000...1235 Ω	max. 300 m
	Contact sensing	max. 300 m
	For DC 0...10 V measuring and control signals	refer to Data Sheet of the signal delivering device
<b>Electrical connections</b>	Connection terminals	spring cage terminals
	For wires	0.6 mm dia....2.5 mm <sup>2</sup>
	For stranded wires without ferrules	0.25...2.5 mm <sup>2</sup>
	For stranded wires with ferrules	0.25...1.5 mm <sup>2</sup>
<b>Degrees of protection</b>	Degree of protection of housing to IEC 60 529	IP 20 (when mounted)
	Protection class to EN 60 730	device suited for use with equipment of protection class II
<b>Environmental conditions</b>	Operation to	IEC/EN 60721-3-3
	Climatic conditions	class 3K23
	Temperature (housing and electronics)	0...50 °C
	Humidity	5...95 % r.h. (non-condensing)
	Mechanical conditions	class 3M11
	Transport to	IEC/EN 60721-3-2
Climatic conditions	class 2K12 / 1K22	
Temperature	-40...+70 °C	
Humidity	5...95 % r.h.	
Mechanical conditions	class 2M4	
<b>Classifications to EN 60 730</b>	Mode of operation, automatic controls	type 1B
	Degree of contamination, controls' environment	2
	Software class	A
	Rated surge voltage	4000 V
	Temperature for ball-pressure test of housing	125 °C



<b>Materials and colors</b>	Terminal base	Polycarbonate, RAL 7035 (light-grey)
	Controller insert	Polycarbonate, RAL 7035 (light-grey)
	Packaging	corrugated cardboard
<b>Standards, directives and approvals</b>	Product standard	EN 60730-1 Automatic electrical controls for household and similar use
	Electromagnetic compatibility (Applications)	For use in residential, commercial and industrial environments
	EU conformity (CE)	See EU declaration of conformity *)
	UL certification	UL916 <a href="https://iq.ulprospector.com">https://iq.ulprospector.com</a>
	RCM-conformity (EMC)	See RCM declaration of conformity *)
	EAC conformity	Eurasia conformity
<b>Environmental compatibility</b>	Product environmental declarations:	CE1E3101de01 *)
	contain data on environmentally compatible product design and assessments (RoHS compliance, materials composition, packaging, environmental benefit, disposal)	CE1E3101de02 *)
Weight, excl. packaging	RLU202	0,334 kg
	RLU220	0,292 kg
	RLU222	0,334 kg
	RLU232	0,437 kg
	RLU236	0,481 kg
*) Documents can be downloaded at <a href="http://www.siemens.com/bt/download">http://www.siemens.com/bt/download</a>		

## Connection diagrams

### Internal diagrams

RLU202

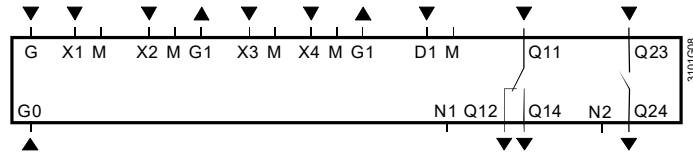

RLU220

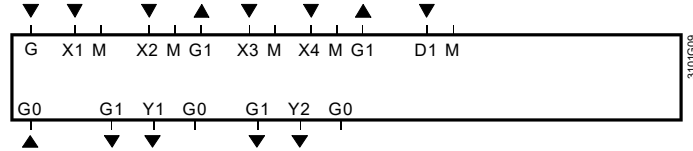

RLU222

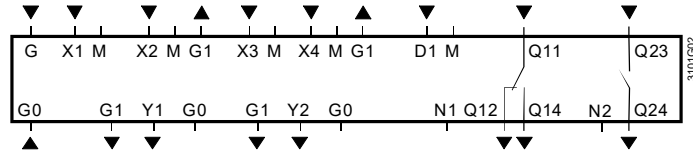

RLU232

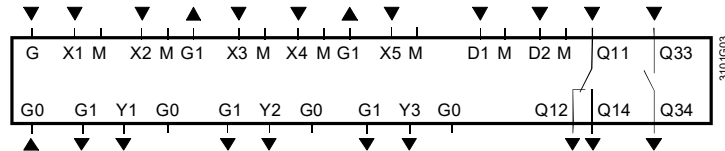

RLU236

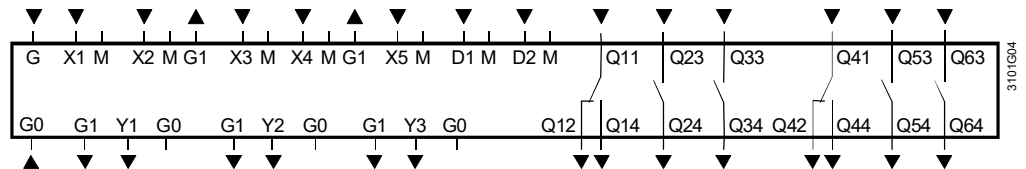

### Legend

G, G0	Rated voltage AC 24 V
G1	Output voltage AC 24 V for powering external active sensors, signal sources, monitors or setting units
M	Measuring neutral for signal input
G0	System neutral for signal output
X...	Universal signal inputs for LG-Ni 1000, 2x LG-Ni 1000 (averaging), T1, Pt 1000, DC 0...10 V, 0...1000 Ω (= REM), 1000...1175 Ω (= REL)
X..., D...	Contact sensing (potential-free)
Y...	Control or status outputs, analog DC 0...10 V
Q...	Potential-free relay outputs for AC 24...230 V
N1, N2	Neutral conductor connection for radio interference suppression elements

### Notes

- Each terminal (spring cage terminal) can only accommodate 1 solid wire or 1 stranded wire. Double terminals are internally interconnected
- If a 3-position AC 230 V actuator is used, the radio suppression element must be activated: Connect terminal N1 to the neutral conductor and fit a wire link between N1 and N2 (see connection diagram 5)

## Connection diagrams

Connections on the measuring side

Examples:

*Connection diagram 1: Measuring section with passive main and auxiliary sensors and passive signal source*

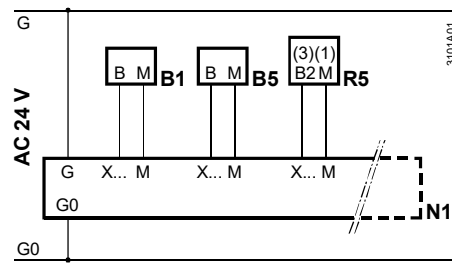

*Connection diagram 2: Measuring section with active sensor and active signal source*

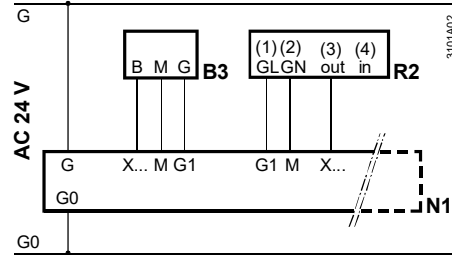

*Connection diagrams 3 and 4: Measuring section with CO2/VOC- and CO2-evaluation*

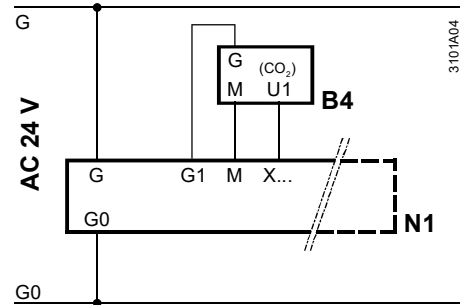
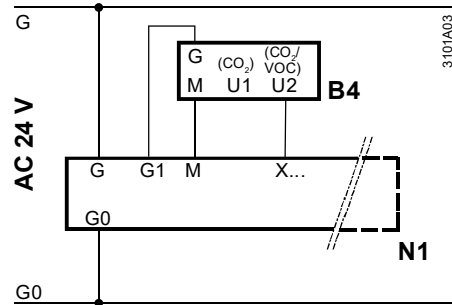

Connections on the control and monitoring side

*Connection diagram 5:*

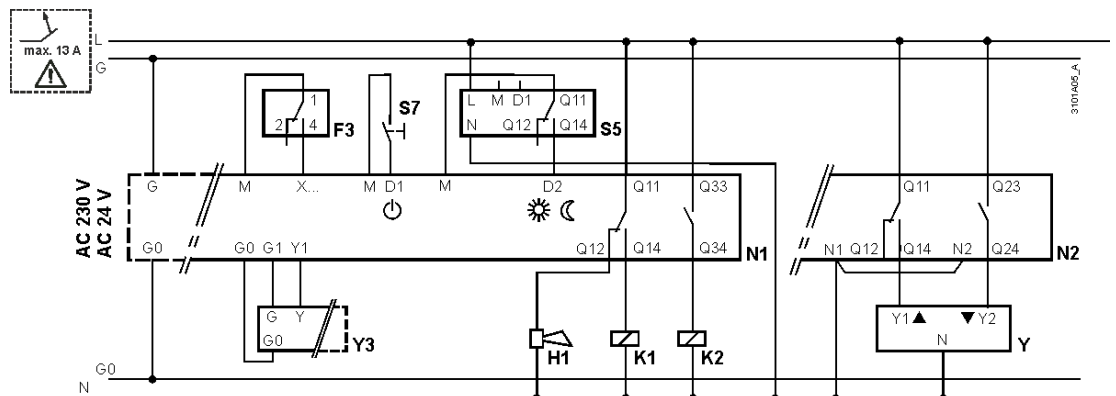

Legend to the connection diagrams 1 through 5

N1	Universal controller RLU2...	K1	Fan release relay
N2	Universal controller RLU222	K2	Pump release relay
B1	Supply air temperature sensor QAM2120.040	R2	Setpoint adjuster BSG61
B3	Frost sensor QAF63.2/QAF63...	R5	Setpoint readjuster BSG21.5
B4	CO <sub>2</sub> /VOC sensor QPA2002/2002D	S4	On/off switch "Locking signal"
B4	CO <sub>2</sub> sensor QPA2000	S5	Digital time switch SEH62.1
B5	Room temperature sensor QAA24	S7	Manual switch "On/Standby"
F3	Frost unit QAF81...	Y	Actuating device with 3-position control
H1	Horn for fault status message from fan	Y3	Actuating device for heating

## Preprogrammed standard applications

Note The plant diagrams / connection diagrams assigned to the basic types are only examples.

Controller- / basic type	Application no. / description	Plant diagram / connection diagram
RLU202 A01	<b>ADA006 LU0 HQ</b> Extract air (room) temperature control with electric air heater battery. <i>Options:</i> <ul style="list-style-type: none"> <li>• Minimum and maximum limitation of the supply air temperature</li> <li>• Outside temperature-dependent functions</li> <li>• Remote setpoint readjuster</li> <li>• 2-stage electric air heater battery</li> <li>• Comfort / Protection Mode changeover (time switch)</li> </ul>	
RLU202 A02	<b>ADA012 LU0 HQ</b> Supply air temperature control with electric air heater battery. <i>Options:</i> <ul style="list-style-type: none"> <li>• Room temperature cascade control</li> <li>• Outside temperature-dependent functions</li> <li>• Remote setpoint readjuster</li> <li>• 2-stage electric air heater battery</li> <li>• Comfort / Protection Mode changeover (time switch)</li> </ul>	
RLU202 A03	<b>ADA014 LU0 HQ</b> Supply air temperature control with hot water heating coil. <i>Options:</i> <ul style="list-style-type: none"> <li>• Room temperature cascade control</li> <li>• Outside temperature-dependent functions</li> <li>• Remote setpoint readjuster</li> <li>• Comfort / Protection Mode changeover (time switch)</li> </ul>	
RLU202 A04	<b>ADB003 LU0 HQ</b> Extract air (room) temperature control with DX cooler battery. <i>Options:</i> <ul style="list-style-type: none"> <li>• Minimum and maximum limitation of the supply air temperature</li> <li>• Outside temperature-dependent functions</li> <li>• Remote setpoint readjuster</li> <li>• 2-stage DX cooler battery</li> <li>• Comfort / Protection Mode changeover (time switch)</li> </ul>	
RLU202 A05	<b>ADB007 LU0 HQ</b> Supply air temperature control with DX cooler battery. <i>Options:</i> <ul style="list-style-type: none"> <li>• Room temperature cascade control</li> <li>• Outside temperature-dependent functions</li> <li>• Remote setpoint readjuster</li> <li>• 2-stage DX cooler battery</li> <li>• Comfort / Protection Mode changeover (time switch)</li> </ul>	
RLU202 A06	<b>AEC001 LU0 HQ</b> Extract air (room) temperature control with hot water heating coil and DX cooler battery. <i>Options:</i> <ul style="list-style-type: none"> <li>• Minimum and maximum limitation of the supply air temperature</li> <li>• Outside temperature-dependent functions</li> <li>• Remote setpoint readjuster</li> <li>• Comfort / Protection Mode changeover (time switch)</li> </ul>	

Controller- / basic type	Application no. / description	Plant diagram / connection diagram
RLU202 A07	<b>AEC002 LU0 HQ</b> Supply air temperature control with hot water heating coil and DX cooler battery. <i>Options:</i> <ul style="list-style-type: none"> <li>• Room temperature cascade control</li> <li>• Outside temperature-dependent functions</li> <li>• Remote setpoint readjuster</li> <li>• Comfort / Protection Mode changeover (time switch)</li> </ul>	
RLU202 U01	<b>ADKA02 LU0 HQ</b> Extract air (room) humidity control (r.h.) with spray humidifier. <i>Options:</i> <ul style="list-style-type: none"> <li>• Maximum limitation of the air humidity</li> <li>• Remote setpoint adjuster</li> <li>• 2-stage spray humidifier</li> <li>• Comfort / Protection Mode changeover (time switch)</li> </ul>	
RLU202 U02	<b>ADI003 LU0 HQ</b> Extract air (room) humidity control (r.h.) with DX cooler battery. <i>Options:</i> <ul style="list-style-type: none"> <li>• Additional maximum selection from internal and external signal</li> <li>• Room temperature-dependent shifting of humidity setpoint</li> <li>• Remote setpoint adjuster</li> <li>• 2-stage DX cooler battery</li> <li>• Comfort / Protection Mode changeover (time switch)</li> </ul>	
RLU202 U03	<b>ADI005 LU0 HQ</b> Extract air (room) humidity control (a.h.) with DX cooler battery. <i>Options:</i> <ul style="list-style-type: none"> <li>• Additional maximum selection from internal and external signal</li> <li>• Room temperature-dependent shifting of humidity setpoint</li> <li>• Remote setpoint adjuster</li> <li>• 2-stage DX cooler battery</li> <li>• Comfort / Protection Mode changeover (time switch)</li> </ul>	
RLU202 U04	<b>ADZA01 LU0 HQ</b> Extract air (room) humidity control (r.h.) with spray humidifier and DX cooler battery. <i>Options:</i> <ul style="list-style-type: none"> <li>• Maximum limitation of the supply air humidity</li> <li>• Additional maximum selection from internal and external signal</li> <li>• Remote setpoint adjuster</li> <li>• Comfort / Protection Mode changeover (time switch)</li> </ul>	
RLU202 U05	<b>AZZ001 LU0 HQ</b> Indoor air quality control with fan control. <i>Options:</i> <ul style="list-style-type: none"> <li>• Additional maximum selection from internal and external signal</li> <li>• Outside temperature-dependent functions</li> <li>• Remote setpoint adjuster</li> <li>• 2-speed fan</li> <li>• Comfort / Protection Mode changeover (time switch)</li> </ul>	
RLU202 U06	<b>HZC001 LU0 HQ</b> Temperature control of mixing heating circuit. <i>Options:</i> <ul style="list-style-type: none"> <li>• Minimum limitation of the return temperature</li> <li>• Outside temperature-dependent functions</li> <li>• Remote setpoint adjuster</li> <li>• Comfort / Protection Mode changeover (time switch)</li> </ul>	

Controller- / basic type	Application no. / description	Plant diagram / connection diagram
RLU202 U07	<b>HZC002 LU0 HQ</b> Boiler temperature control (substitute for RCA12.2) <i>Application:</i> Minimum limitation of the boiler return temperature <i>Options:</i> <ul style="list-style-type: none"> <li>• Remote setpoint adjuster (absolute)</li> <li>• Comfort / Protection Mode changeover (time switch)</li> </ul>	
RLU202 U08	<b>ADC019 LU0 HQ</b> Universal control (substitute for RKN2 / RKN22) <i>Application:</i> Temperature control (on/off pump control) <i>Options:</i> <ul style="list-style-type: none"> <li>• Remote setpoint adjuster (absolute)</li> <li>• Comfort / Protection changeover</li> </ul>	
RLU202 U09	<b>SA0001 LU0 HQ</b> Differential temperature control (substitute for RSA24) <i>Application:</i> Solar heat storage plant <i>Options:</i> <ul style="list-style-type: none"> <li>• Maximum limitation of the boiler temperature</li> <li>• Minimum limitation of the charging temperature</li> <li>• Comfort / Protection Mode changeover (time switch)</li> </ul>	
RLU202 U10	<b>ZZZ001 LU0 HQ</b> 3-position actuator	
RLU202 U11	<b>ZZZ002 LU0 HQ</b> Variable 2-step switch	
RLU220 A01	<b>ADA001 LU2 HQ</b> Extract air (room) temperature control with hot water heating coil. <i>Options:</i> <ul style="list-style-type: none"> <li>• Minimum and maximum limitation of the supply air temperature</li> <li>• Remote setpoint readjuster</li> <li>• Outside temperature-dependent functions</li> <li>• Comfort / Protection Mode changeover (time switch)</li> </ul>	
RLU220 A02	<b>ADA008 LU2 HQ</b> Supply air temperature control with hot water heating coil. <i>Options:</i> <ul style="list-style-type: none"> <li>• Room temperature cascade control</li> <li>• Remote setpoint readjuster</li> <li>• Outside temperature-dependent functions</li> <li>• Comfort / Protection Mode changeover (time switch)</li> </ul>	

Controller- / basic type	Application no. / description	Plant diagram / connection diagram
RLU220 A03	<b>ADA003 LU2 HQ</b> Extract air (room) temperature control with hot water heating coil and frost protection. <i>Options:</i> <ul style="list-style-type: none"> <li>• Minimum and maximum limitation of the supply air temperature</li> <li>• Outside temperature-dependent functions</li> <li>• Comfort / Protection Mode changeover (time switch)</li> </ul>	
RLU220 A04	<b>ADA010 LU2 HQ</b> Supply air temperature control with hot water heating coil and frost protection. <i>Options:</i> <ul style="list-style-type: none"> <li>• Room temperature cascade control</li> <li>• Outside temperature-dependent functions</li> <li>• Comfort / Protection Mode changeover (time switch)</li> </ul>	
RLU220 A05	<b>ADA017 LU2 HQ</b> Extract air (room) temperature control with hot water heating coil, frost protection. <i>Options:</i> <ul style="list-style-type: none"> <li>• Minimum and maximum limitation of the supply air temperature</li> <li>• Remote setpoint readjuster</li> <li>• Comfort / Protection Mode changeover (time switch)</li> </ul>	
RLU220 A06	<b>ADB001 LU2 HQ</b> Extract air (room) temperature control with chilled water cooling coil. <i>Options:</i> <ul style="list-style-type: none"> <li>• Minimum and maximum limitation of the supply air temperature</li> <li>• Remote setpoint readjuster</li> <li>• Outside temperature-dependent functions</li> <li>• Comfort / Protection Mode changeover (time switch)</li> </ul>	
RLU220 A07	<b>ADB005 LU2 HQ</b> Supply air temperature control with chilled water cooling coil. <i>Options:</i> <ul style="list-style-type: none"> <li>• Room temperature cascade control</li> <li>• Remote setpoint readjuster</li> <li>• Outside temperature-dependent functions</li> <li>• Comfort / Protection Mode changeover (time switch)</li> </ul>	
RLU220 A08	<b>ACAD01 LU2 HQ</b> Extract air (room) temperature control with mixed air dampers and outside temperature-dependent functions. <i>Options:</i> <ul style="list-style-type: none"> <li>• Additional maximum selection from internal and external signal</li> <li>• Comfort / Protection Mode changeover (time switch)</li> </ul>	
RLU220 A09	<b>ABC001 LU2 HQ</b> Supply air temperature control with heating / cooling coil and frost protection. <i>Options:</i> <ul style="list-style-type: none"> <li>• Outside temperature-dependent functions</li> <li>• Comfort / Protection Mode changeover (time switch)</li> </ul>	

Controller- / basic type	Application no. / description	Plant diagram / connection diagram
RLU220 A10	<b>ADC021 LU2 HQ</b> Extract air (room) temperature control with hot water heating coil and chilled water cooling coil. <i>Options:</i> <ul style="list-style-type: none"> <li>• Room temperature cascade control</li> <li>• Outside temperature-dependent functions</li> <li>• Remote setpoint readjuster</li> <li>• Comfort / Protection Mode changeover (time switch)</li> </ul>	
RLU220 A11	<b>ADC023 LU2 HQ</b> Supply air temperature control with hot water heating coil and chilled water cooling coil. <i>Options:</i> <ul style="list-style-type: none"> <li>• Room temperature cascade control</li> <li>• Outside temperature-dependent functions</li> <li>• Remote setpoint readjuster</li> <li>• Comfort / Protection Mode changeover (time switch)</li> </ul>	
RLU220 A12	<b>ADC022 LU2 HQ</b> Extract air (room) temperature control with hot water heating coil, frost protection, chilled water cooling coil. <i>Options:</i> <ul style="list-style-type: none"> <li>• Minimum and maximum limitation of the supply air temperature</li> <li>• Outside temperature-dependent functions</li> <li>• Comfort / Protection Mode changeover (time switch)</li> </ul>	
RLU220 A13	<b>ADC024 LU2 HQ</b> Supply air temperature control with hot water heating coil, frost protection, chilled water cooling coil. <i>Options:</i> <ul style="list-style-type: none"> <li>• Room temperature cascade control</li> <li>• Outside temperature-dependent functions</li> <li>• Comfort / Protection Mode changeover (time switch)</li> </ul>	
RLU220 A14	<b>AEAF03 LU2 HQ</b> Extract air (room) temperature control with closed-circuit heat recovery system and hot water heating coil. <i>Options:</i> <ul style="list-style-type: none"> <li>• Minimum and maximum limitation of the supply air temperature</li> <li>• Outside temperature-dependent functions</li> <li>• Remote setpoint readjuster</li> <li>• Comfort / Protection Mode changeover (time switch)</li> </ul>	
RLU220 A15	<b>AEAF04 LU2 HQ</b> Supply air temperature control with closed-circuit heat recovery system and hot water heating coil. <i>Options:</i> <ul style="list-style-type: none"> <li>• Room temperature cascade control</li> <li>• Outside temperature-dependent functions</li> <li>• Remote setpoint readjuster</li> <li>• Comfort / Protection Mode changeover (time switch)</li> </ul>	
RLU220 A16	<b>AEAD03 LU2 HQ</b> Extract air (room) temperature control with mixed air dampers, hot water heating coil, frost protection. <i>Options:</i> <ul style="list-style-type: none"> <li>• Minimum and maximum limitation of the supply air temperature</li> <li>• Outside temperature-dependent functions</li> <li>• Comfort / Protection Mode changeover (time switch)</li> </ul>	



Controller- / basic type	Application no. / description	Plant diagram / connection diagram
RLU220 A17	<b>AEAD04 LU2 HQ</b> Supply air temperature control with mixed air dampers, hot water heating coil, frost protection. <i>Options:</i> <ul style="list-style-type: none"> <li>• Room temperature cascade control</li> <li>• Outside temperature-dependent functions</li> <li>• Comfort / Protection Mode changeover (time switch)</li> </ul>	
RLU220 A18	<b>ADB012 LU2 HQ</b> Extract air (room) temperature control with chilled water cooling coil and 2 cooling towers. <i>Options:</i> <ul style="list-style-type: none"> <li>• Minimum and maximum limitation of the supply air temperature</li> <li>• Outside temperature-dependent functions</li> <li>• Remote setpoint readjuster</li> <li>• Comfort / Protection Mode changeover (time switch)</li> </ul>	
RLU220 U01	<b>ADKA01 LU2 HQ</b> Extract air (room) humidity control (r.h.) with spray humidifier. <i>Options:</i> <ul style="list-style-type: none"> <li>• Maximum limitation of the supply air humidity</li> <li>• Remote setpoint adjuster</li> <li>• Comfort / Protection Mode changeover (time switch)</li> </ul>	
RLU220 U02	<b>ADI001 LU2 HQ</b> Extract air (room) humidity control (r.h.) with chilled water cooling coil. <i>Options:</i> <ul style="list-style-type: none"> <li>• Additional maximum selection from internal and external signal</li> <li>• Remote setpoint adjuster</li> <li>• Comfort / Protection Mode changeover (time switch)</li> </ul>	
RLU220 U03	<b>ADI002 LU2 HQ</b> Extract air (room) humidity control (a.h.) with chilled water cooling coil. <i>Options:</i> <ul style="list-style-type: none"> <li>• Additional maximum selection from internal and external signal</li> <li>• Remote setpoint adjuster</li> <li>• Comfort / Protection Mode changeover (time switch)</li> </ul>	
RLU220 U04	<b>PB0001 LU2 HQ</b> Differential pressure control of water with speed-controlled pump. <i>Options:</i> <ul style="list-style-type: none"> <li>• Minimum and maximum limitation of the differential pressure</li> <li>• Remote setpoint adjuster</li> <li>• Comfort / Protection Mode changeover (time switch)</li> </ul>	
RLU220 U05	<b>PB0004 LU2 HQ</b> Differential pressure control of water with speed-controlled pumps. <i>Options:</i> <ul style="list-style-type: none"> <li>• Minimum and maximum pressure limit controller</li> <li>• Outside temperature-dependent functions</li> <li>• Remote setpoint adjuster</li> <li>• Comfort / Protection Mode changeover (time switch)</li> </ul>	

Controller- / basic type	Application no. / description	Plant diagram / connection diagram
RLU220 U06	<b>AZL001 LU2 HQ</b> Differential pressure control of air with speed-controlled fan. <i>Options:</i> <ul style="list-style-type: none"> <li>• Minimum and maximum limitation of the differential pressure</li> <li>• Remote setpoint adjuster</li> <li>• Comfort / Protection Mode changeover (time switch)</li> </ul>	
RLU220 U07	<b>AZL004 LU2 HQ</b> Differential pressure control of air with speed-controlled fans. <i>Options:</i> <ul style="list-style-type: none"> <li>• Minimum and maximum pressure limit controller</li> <li>• Outside temperature-dependent functions</li> <li>• Remote setpoint adjuster</li> <li>• Comfort / Protection Mode changeover (time switch)</li> </ul>	
RLU220 U08	<b>AAZD01 LU2 HQ</b> Indoor air quality control with mixed air dampers. <i>Options:</i> <ul style="list-style-type: none"> <li>• Additional maximum selection from internal and external signal</li> <li>• Remote setpoint adjuster</li> <li>• Comfort / Protection Mode changeover (time switch)</li> </ul>	
RLU220 U09	<b>CZC002 LU2 HQ</b> Temperature control of chilled ceilings. <i>Options:</i> <ul style="list-style-type: none"> <li>• Setpoint compensation depending on humidity</li> <li>• Deviation alarm</li> <li>• Comfort / Protection Mode changeover (time switch)</li> </ul>	
RLU220 U10	<b>ADC025 LU2 HQ</b> Universal control (substitute for RKN8 / RKN88) <i>Application:</i> Temperature control (modulating valve control) <i>Options:</i> <ul style="list-style-type: none"> <li>• Remote setpoint adjuster (absolute)</li> <li>• Comfort / Protection Mode changeover (time switch)</li> </ul>	
RLU222 A01	<b>ADA006 LU2 HQ</b> Extract air (room) temperature control with electric air heater battery. <i>Options:</i> <ul style="list-style-type: none"> <li>• Minimum and maximum limitation of the supply air temperature</li> <li>• Outside temperature-dependent functions</li> <li>• Remote setpoint readjuster</li> <li>• 2-stage electric air heater battery</li> <li>• Comfort / Protection Mode changeover (time switch)</li> </ul>	
RLU222 A02	<b>ADA012 LU2 HQ</b> Supply air temperature control with electric air heater battery. <i>Options:</i> <ul style="list-style-type: none"> <li>• Room temperature cascade control</li> <li>• Outside temperature-dependent functions</li> <li>• Remote setpoint readjuster</li> <li>• 2-stage electric air heater battery</li> <li>• Comfort / Protection Mode changeover (time switch)</li> </ul>	

Controller- / basic type	Application no. / description	Plant diagram / connection diagram
RLU222 A03	<b>ADA014 LU2 HQ</b> Supply air temperature control with hot water heating coil. <i>Options:</i> <ul style="list-style-type: none"> <li>• Room temperature cascade control</li> <li>• Outside temperature-dependent functions</li> <li>• Remote setpoint readjuster</li> <li>• Comfort / Protection Mode changeover (time switch)</li> </ul>	
RLU222 A04	<b>ADA004 LU2 HQ</b> Extract air (room) temperature control with hot water heating coil, frost protection and fan release. <i>Options:</i> <ul style="list-style-type: none"> <li>• Minimum and maximum limitation of the supply air temperature</li> <li>• Outside temperature-dependent functions</li> <li>• Comfort / Protection Mode changeover (time switch)</li> </ul>	
RLU222 A05	<b>ADA005 LU2 HQ</b> Extract air (room) temperature control with hot water heating coil, frost protection and fan release. <i>Options:</i> <ul style="list-style-type: none"> <li>• Minimum and maximum limitation of the supply air temperature</li> <li>• Remote setpoint readjuster</li> <li>• Comfort / Protection Mode changeover (time switch)</li> </ul>	
RLU222 A06	<b>ADA0011 LU2 HQ</b> Supply air temperature control with hot water heating coil, frost protection and fan release. <i>Options:</i> <ul style="list-style-type: none"> <li>• Room temperature cascade control</li> <li>• Outside temperature-dependent functions</li> <li>• Comfort / Protection Mode changeover (time switch)</li> </ul>	
RLU222 A07	<b>ADB003 LU2 HQ</b> Extract air (room) temperature control with DX cooler battery. <i>Options:</i> <ul style="list-style-type: none"> <li>• Minimum and maximum limitation of the supply air temperature</li> <li>• Outside temperature-dependent functions</li> <li>• Remote setpoint readjuster</li> <li>• 2-stage DX cooler battery</li> <li>• Comfort / Protection Mode changeover (time switch)</li> </ul>	
RLU222 A08	<b>ADB007 LU2 HQ</b> Supply air temperature control with DX cooler battery. <i>Options:</i> <ul style="list-style-type: none"> <li>• Room temperature cascade control</li> <li>• Outside temperature-dependent functions</li> <li>• Remote setpoint readjuster</li> <li>• 2-stage DX cooler battery</li> <li>• Comfort / Protection Mode changeover (time switch)</li> </ul>	
RLU222 A09	<b>ADC002 LU2 HQ</b> Extract air (room) temperature control with hot water heating coil and chilled water cooling coil. <i>Options:</i> <ul style="list-style-type: none"> <li>• Room temperature cascade control</li> <li>• Outside temperature-dependent functions</li> <li>• Remote setpoint readjuster</li> <li>• Comfort / Protection Mode changeover (time switch)</li> </ul>	

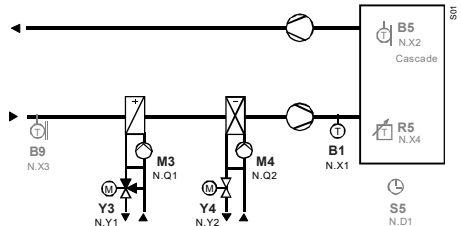
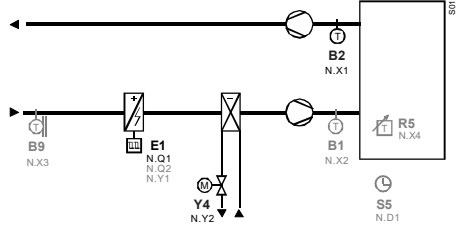
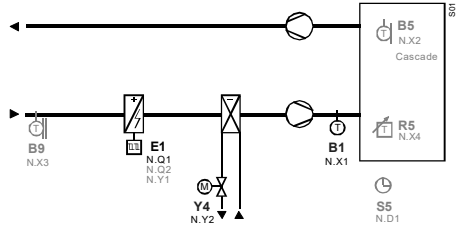
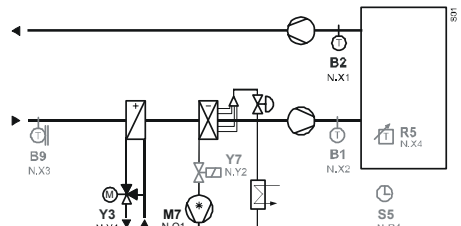
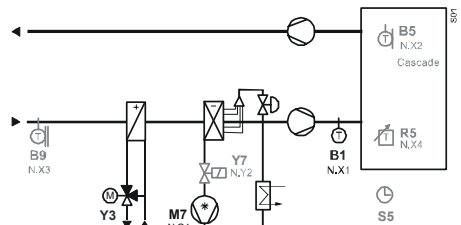
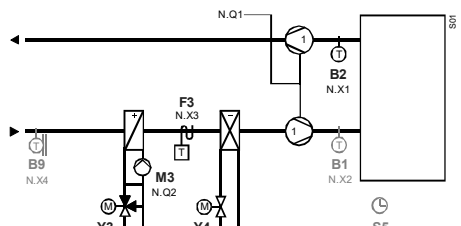
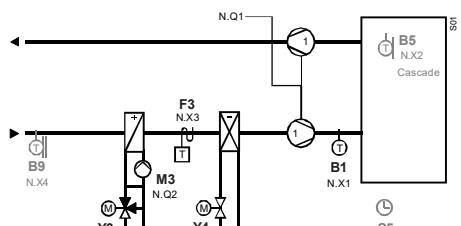
Controller- / basic type	Application no. / description	Plant diagram / connection diagram
RLU222 A10	<b>ADC010 LU2 HQ</b> Supply air temperature control with hot water heating coil and chilled water cooling coil. <i>Options:</i> <ul style="list-style-type: none"> <li>• Room temperature cascade control</li> <li>• Outside temperature-dependent functions</li> <li>• Remote setpoint readjuster</li> <li>• Comfort / Protection Mode changeover (time switch)</li> </ul>	
RLU222 A11	<b>ADC004 LU2 HQ</b> Extract air (room) temperature control with electric air heater battery and chilled water cooling coil. <i>Options:</i> <ul style="list-style-type: none"> <li>• Minimum and maximum limitation of the supply air temperature</li> <li>• Outside temperature-dependent functions</li> <li>• Remote setpoint readjuster</li> <li>• 2-stage electric air heater battery</li> <li>• Comfort / Protection Mode changeover (time switch)</li> </ul>	
RLU222 A12	<b>ADC012 LU2 HQ</b> Supply air temperature control with electric air heater battery and chilled water cooling coil. <i>Options:</i> <ul style="list-style-type: none"> <li>• Room temperature cascade control</li> <li>• Outside temperature-dependent functions</li> <li>• Remote setpoint readjuster</li> <li>• 2-stage electric air heater battery</li> <li>• Comfort / Protection Mode changeover (time switch)</li> </ul>	
RLU222 A13	<b>ADC003 LU2 HQ</b> Extract air (room) temperature control with hot water heating coil and DX cooler battery. <i>Options:</i> <ul style="list-style-type: none"> <li>• Minimum and maximum limitation of the supply air temperature</li> <li>• Outside temperature-dependent functions</li> <li>• Remote setpoint readjuster</li> <li>• 2-stage DX cooler battery</li> <li>• Comfort / Protection Mode changeover (time switch)</li> </ul>	
RLU222 A14	<b>ADC011 LU2 HQ</b> Supply air temperature control with hot water heating coil and DX cooler battery. <i>Options:</i> <ul style="list-style-type: none"> <li>• Room temperature cascade control</li> <li>• Outside temperature-dependent functions</li> <li>• Remote setpoint readjuster</li> <li>• 2-stage DX cooler battery</li> <li>• Comfort / Protection Mode changeover (time switch)</li> </ul>	
RLU222 A15	<b>ADC006 LU2 HQ</b> Extract air (room) temperature control with hot water heating coil, frost protection, chilled water cooling coil and fan release. <i>Options:</i> <ul style="list-style-type: none"> <li>• Minimum and maximum limitation of the supply air temperature</li> <li>• Outside temperature-dependent functions</li> <li>• Comfort / Protection Mode changeover (time switch)</li> </ul>	
RLU222 A16	<b>ADC014 LU2 HQ</b> Supply air temperature control with hot water heating coil, frost protection, chilled water cooling coil and fan release. <i>Options:</i> <ul style="list-style-type: none"> <li>• Room temperature cascade control</li> <li>• Outside temperature-dependent functions</li> <li>• Comfort / Protection Mode changeover (time switch)</li> </ul>	

Controller- / basic type	Application no. / description	Plant diagram / connection diagram
RLU222 A17	<b>ADC007 LU2 HQ</b> Extract air (room) temperature control with hot water heating coil, frost protection, DX cooler battery and fan release. <i>Options:</i> <ul style="list-style-type: none"> <li>• Minimum and maximum limitation of the supply air temperature</li> <li>• Outside temperature-dependent functions</li> <li>• Comfort / Protection Mode changeover (time switch)</li> </ul>	
RLU222 A18	<b>ADC016 LU2 HQ</b> Supply air temperature control with hot water heating coil, frost protection, DX cooler battery and fan release. <i>Options:</i> <ul style="list-style-type: none"> <li>• Room temperature cascade control</li> <li>• Outside temperature-dependent functions</li> <li>• Comfort / Protection Mode changeover (time switch)</li> </ul>	
RLU222 A19	<b>AEAG01 LU2 HQ</b> Extract air (room) temperature control with closed-circuit heat recovery system and hot water heating coil. <i>Options:</i> <ul style="list-style-type: none"> <li>• Minimum and maximum limitation of the supply air temperature</li> <li>• Outside temperature-dependent functions</li> <li>• Remote setpoint readjuster</li> <li>• Comfort / Protection Mode changeover (time switch)</li> </ul>	
RLU222 A20	<b>AEAG02 LU2 HQ</b> Supply air temperature control with closed-circuit heat recovery system and hot water heating coil. <i>Options:</i> <ul style="list-style-type: none"> <li>• Room temperature cascade control</li> <li>• Outside temperature-dependent functions</li> <li>• Remote setpoint readjuster</li> <li>• Comfort / Protection Mode changeover (time switch)</li> </ul>	
RLU222 A21	<b>AEAD01 LU2 HQ</b> Extract air (room) temperature control with mixed air dampers, hot water heating coil, frost protection and fan release. <i>Options:</i> <ul style="list-style-type: none"> <li>• Minimum and maximum limitation of the supply air temperature</li> <li>• Outside temperature-dependent functions</li> <li>• Comfort / Protection Mode changeover (time switch)</li> </ul>	
RLU222 A22	<b>AEAD02 LU2 HQ</b> Supply air temperature control with mixed air dampers, hot water heating coil, frost protection and fan release. <i>Options:</i> <ul style="list-style-type: none"> <li>• Room temperature cascade control</li> <li>• Outside temperature-dependent functions</li> <li>• Comfort / Protection Mode changeover (time switch)</li> </ul>	
RLU222 A23	<b>ADB009 LU2 HQ</b> Extract air (room) temperature control with chilled water cooling coil and 2 cooling towers. <i>Options:</i> <ul style="list-style-type: none"> <li>• Minimum and maximum limitation of the supply air temperature</li> <li>• Outside temperature-dependent functions</li> <li>• Remote setpoint readjuster</li> <li>• Comfort / Protection Mode changeover (time switch)</li> </ul>	

Controller- / basic type	Application no. / description	Plant diagram / connection diagram
RLU222 A24	<b>AECD01 LU2 HQ</b> Extract air (room) temperature control with mixed air dampers, hot water heating coil and DX cooler battery. <i>Options:</i> <ul style="list-style-type: none"> <li>• Minimum and maximum limitation of the supply air temperature</li> <li>• Outside temperature-dependent functions</li> <li>• Remote setpoint readjuster</li> <li>• Comfort / Protection Mode changeover (time switch)</li> </ul>	
RLU222 A25	<b>AECD04 LU2 HQ</b> Supply air temperature control with mixed air dampers, hot water heating coil and DX cooler battery. <i>Options:</i> <ul style="list-style-type: none"> <li>• Room temperature cascade control</li> <li>• Outside temperature-dependent functions</li> <li>• Remote setpoint readjuster</li> <li>• Comfort / Protection Mode changeover (time switch)</li> </ul>	
RLU222 A26	<b>AECD02 LU2 HQ</b> Extract air (room) temperature control with mixed air dampers, hot water heating coil and DX cooler battery. <i>Options:</i> <ul style="list-style-type: none"> <li>• Minimum and maximum limitation of the supply air temperature</li> <li>• Outside temperature-dependent functions</li> <li>• Remote setpoint readjuster</li> <li>• 2-stage DX cooler battery</li> <li>• Comfort / Protection Mode changeover (time switch)</li> </ul>	
RLU222 A27	<b>AECD05 LU2 HQ</b> Supply air temperature control with mixed air dampers, hot water heating coil and dx cooler battery. <i>Options:</i> <ul style="list-style-type: none"> <li>• Room temperature cascade control</li> <li>• Outside temperature-dependent functions</li> <li>• Remote setpoint readjuster</li> <li>• 2-stage DX cooler battery</li> <li>• Comfort / Protection Mode changeover (time switch)</li> </ul>	
RLU222 A28	<b>AECD03 LU2 HQ</b> Extract air (room) temperature control with mixed air dampers, electric air heater battery and chilled water cooling coil. <i>Options:</i> <ul style="list-style-type: none"> <li>• Minimum and maximum limitation of the supply air temperature</li> <li>• Outside temperature-dependent functions</li> <li>• Remote setpoint readjuster</li> <li>• 2-stage electric air heater battery</li> <li>• Comfort / Protection Mode changeover (time switch)</li> </ul>	
RLU222 A29	<b>AECD06 LU2 HQ</b> Supply air temperature control with mixed air dampers, electric air heater battery and chilled water cooling coil. <i>Options:</i> <ul style="list-style-type: none"> <li>• Room temperature cascade control</li> <li>• Outside temperature-dependent functions</li> <li>• Remote setpoint readjuster</li> <li>• 2-stage electric air heater battery</li> <li>• Comfort / Protection Mode changeover (time switch)</li> </ul>	
RLU222 U01	<b>ADKA02 LU2 HQ</b> Extract air (room) humidity control (r.h.) with spray humidifier. <i>Options:</i> <ul style="list-style-type: none"> <li>• Maximum limitation of the air humidity</li> <li>• Remote setpoint adjuster</li> <li>• 2-stage spray humidifier</li> <li>• Comfort / Protection Mode changeover (time switch)</li> </ul>	

Controller- / basic type	Application no. / description	Plant diagram / connection diagram
RLU222 U02	<b>PB0002 LU2 HQ</b> Differential pressure control of water with speed-controlled pumps. <i>Options:</i> <ul style="list-style-type: none"> <li>• Minimum and maximum pressure limit controller</li> <li>• Outside temperature-dependent functions</li> <li>• Remote setpoint adjuster</li> <li>• Comfort / Protection Mode changeover (time switch)</li> </ul>	
RLU222 U03	<b>AZL002 LU2 HQ</b> Differential pressure control of air with speed-controlled fans. <i>Options:</i> <ul style="list-style-type: none"> <li>• Minimum and maximum pressure limit controller</li> <li>• Outside temperature-dependent functions</li> <li>• Remote setpoint adjuster</li> <li>• Comfort / Protection Mode changeover (time switch)</li> </ul>	
RLU222 U04	<b>ADI003 LU2 HQ</b> Extract air (room) humidity control (r.h.) with DX cooler battery. <i>Options:</i> <ul style="list-style-type: none"> <li>• Additional maximum selection from internal and external signal</li> <li>• Room temperature-dependent shifting of humidity setpoint</li> <li>• Remote setpoint adjuster</li> <li>• 2-stage DX cooler battery</li> <li>• Comfort / Protection Mode changeover (time switch)</li> </ul>	
RLU222 U05	<b>ADI005 LU2 HQ</b> Extract air (room) humidity control (a.h.) with DX cooler battery. <i>Options:</i> <ul style="list-style-type: none"> <li>• Additional maximum selection from internal and external signal</li> <li>• Room temperature-dependent shifting of humidity setpoint</li> <li>• Remote setpoint adjuster</li> <li>• 2-stage DX cooler battery</li> <li>• Comfort / Protection Mode changeover (time switch)</li> </ul>	
RLU222 U06	<b>AAZD02 LU2 HQ</b> Indoor air quality control with mixed air dampers and fan control. <i>Options:</i> <ul style="list-style-type: none"> <li>• Additional maximum selection from internal and external signal</li> <li>• Outside temperature-dependent functions</li> <li>• Remote setpoint adjuster</li> <li>• 2-speed fan</li> <li>• Comfort / Protection Mode changeover (time switch)</li> </ul>	
RLU222 U07	<b>ADZA01 LU2 HQ</b> Extract air (room) humidity control (r.h.) with spray humidifier and DX cooler battery. <i>Options:</i> <ul style="list-style-type: none"> <li>• Maximum limitation of the supply air humidity</li> <li>• Additional maximum selection from internal and external signal</li> <li>• Remote setpoint adjuster</li> <li>• Comfort / Protection Mode changeover (time switch)</li> </ul>	

Controller- / basic type	Application no. / description	Plant diagram / connection diagram
RLU222 U08	CZC001 LU2 HQ Temperature control of chilled ceilings. <i>Options:</i> <ul style="list-style-type: none"> <li>• Setpoint compensation depending on humidity</li> <li>• Deviation alarm</li> <li>• Comfort / Protection Mode changeover (time switch)</li> </ul>	
RLU222 U09	HZC001 LU2 HQ Temperature control of mixing heating circuit. <i>Options:</i> <ul style="list-style-type: none"> <li>• Minimum limitation of the return temperature</li> <li>• Outside temperature-dependent functions</li> <li>• Remote setpoint adjuster</li> <li>• Comfort / Protection Mode changeover (time switch)</li> </ul>	
RLU222 U10	ZZZ001 LU2 HQ 3-position actuator	
RLU222 U11	ZZZ002 LU2 HQ Variable 2-step switch	
RLU222 U12	ADC019 LU2 HQ Universal control (substitute for RKN2 / RKN22) <i>Application:</i> Temperature control (on/off pump control) <i>Options:</i> <ul style="list-style-type: none"> <li>• Remote setpoint adjuster (absolute)</li> <li>• Comfort / Protection Mode changeover (time switch)</li> </ul>	
RLU222 U13	ADC020 LU2 HQ Universal control (substitute for RKN8 / RKN88) <i>Application:</i> Temperature control (modulating valve control) <i>Options:</i> <ul style="list-style-type: none"> <li>• Remote setpoint adjuster (absolute)</li> <li>• Comfort / Protection Mode changeover (time switch)</li> </ul>	

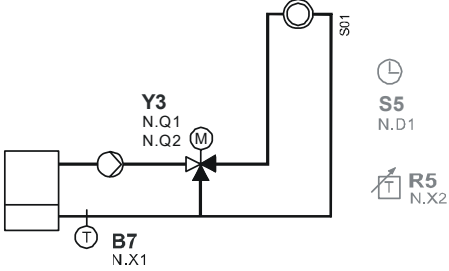
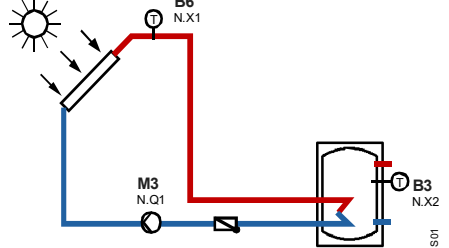
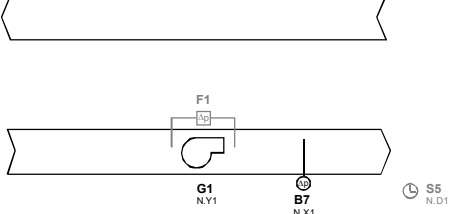
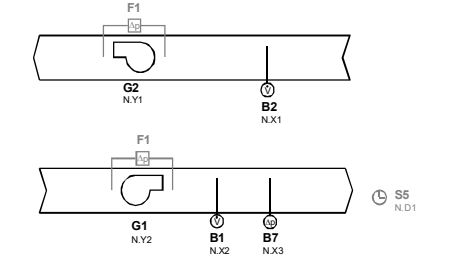
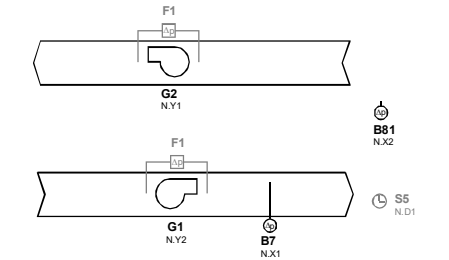
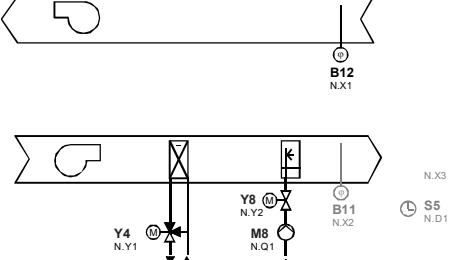

Controller- / basic type	Application no. / description	Plant diagram / connection diagram
RLU222 U14	<b>HZC002 LU2 HQ</b> Boiler temperature control (substitute for RCA12.2) <i>Application:</i> Minimum limitation of the boiler return temperature <i>Options:</i> <ul style="list-style-type: none"> <li>• Remote setpoint adjuster (absolute)</li> <li>• Comfort / Protection Mode changeover (time switch)</li> </ul>	
RLU222 U15	<b>SA0001 LU2 HQ</b> Differential temperature control (substitute for RSA24) <i>Application:</i> Solar heat storage plant <i>Options:</i> <ul style="list-style-type: none"> <li>• Maximum limitation of the boiler temperature</li> <li>• Minimum limitation of the charging temperature</li> </ul>	
RLU222 U16	<b>ABL001 LU2 HQ</b> Supply air differential pressure control <i>Options:</i> <ul style="list-style-type: none"> <li>• Switching via external time switch</li> <li>• Differential pressure monitor</li> </ul>	
RLU222 U17	<b>ADZ001 LU2 HQ</b> Supply air differential pressure control, Extract air volume control <i>Options:</i> <ul style="list-style-type: none"> <li>• Switching via external time switch</li> <li>• Setpoint shift through volumetric supply air flow</li> <li>• Differential pressure monitor</li> </ul>	
RLU222 U18	<b>ADL001 LU2 HQ</b> Supply air and room differential pressure control <i>Options:</i> <ul style="list-style-type: none"> <li>• Switching via external time switch</li> <li>• Differential pressure monitor</li> </ul>	
RLU222 U19	<b>ADZA02 LU2 HQ</b> Extract air (room) humidity control <i>Options:</i> <ul style="list-style-type: none"> <li>• Maximum limitation of supply air humidity</li> <li>• Comfort / Protection Mode changeover (time switch)</li> </ul>	

Controller- / basic type	Application no. / description	Plant diagram / connection diagram
RLU232 A01	<b>AEAF01 LU3 HQ</b> Extract air (room) temperature control with heat recovery, hot water heating coil, frost protection and fan release. <i>Options:</i> <ul style="list-style-type: none"> <li>• Minimum and maximum limitation of the supply air temperature</li> <li>• Outside temperature-dependent functions</li> <li>• Anti-icing protection for heat recovery</li> <li>• Comfort / Economy changeover</li> <li>• Comfort / Protection Mode changeover (time switch)</li> </ul>	
RLU232 A02	<b>AEAF02 LU3 HQ</b> Supply air temperature control with heat recovery, hot water heating coil, frost protection and fan release <i>Options:</i> <ul style="list-style-type: none"> <li>• Room temperature cascade control</li> <li>• Outside temperature-dependent functions</li> <li>• Anti-icing protection for heat recovery</li> <li>• Comfort / Economy changeover</li> <li>• Comfort / Protection Mode changeover (time switch)</li> </ul>	
RLU232 A03	<b>ADC015 LU3 HQ</b> Supply air temperature control with hot water heating coil, frost protection, chilled water cooling coil and fan release <i>Options:</i> <ul style="list-style-type: none"> <li>• Room temperature cascade control</li> <li>• Outside temperature-dependent functions</li> <li>• Comfort / Economy changeover</li> <li>• Comfort / Protection Mode changeover (time switch)</li> </ul>	
RLU232 A04	<b>AECG01 LU3 HQ</b> Extract air (room) temperature control with closed-circuit heat recovery system, hot water heating coil and chilled water cooling coil. <i>Options:</i> <ul style="list-style-type: none"> <li>• Minimum and maximum limitation of the supply air temperature</li> <li>• Outside temperature-dependent functions</li> <li>• Anti-icing protection for heat recovery</li> <li>• Remote setpoint readjuster</li> <li>• Comfort / Economy changeover</li> <li>• Comfort / Protection Mode changeover (time switch)</li> </ul>	
RLU232 A05	<b>AECG02 LU3 HQ</b> Supply air temperature control with closed-circuit heat recovery system, hot water heating coil and chilled water cooling coil. <i>Options:</i> <ul style="list-style-type: none"> <li>• Room temperature cascade control</li> <li>• Outside temperature-dependent functions</li> <li>• Anti-icing protection for heat recovery</li> <li>• Remote setpoint readjuster</li> <li>• Comfort / Economy changeover</li> <li>• Comfort / Protection Mode changeover (time switch)</li> </ul>	
RLU232 A06	<b>AECF01 LU3 HQ</b> Extract air (room) temperature control with heat recovery, hot water heating coil and chilled water cooling coil. <i>Options:</i> <ul style="list-style-type: none"> <li>• Minimum and maximum limitation of the supply air temperature</li> <li>• Outside temperature-dependent functions</li> <li>• Anti-icing protection for heat recovery</li> <li>• Remote setpoint readjuster</li> <li>• Comfort / Economy changeover</li> <li>• Comfort / Protection Mode changeover (time switch)</li> </ul>	

Controller- / basic type	Application no. / description	Plant diagram / connection diagram
RLU232 A07	<b>AECF03 LU3 HQ</b> Supply air temperature control with heat recovery, hot water heating coil and chilled water cooling coil. <i>Options:</i> <ul style="list-style-type: none"> <li>• Room temperature cascade control</li> <li>• Outside temperature-dependent functions</li> <li>• Anti-icing protection for heat recovery</li> <li>• Remote setpoint readjuster</li> <li>• Comfort / Economy changeover</li> <li>• Comfort / Protection Mode changeover (time switch)</li> </ul>	
RLU232 A08	<b>AECF02 LU3 HQ</b> Extract air (room) temperature control with heat recovery, hot water heating coil, frost protection, chilled water cooling coil and fan release. <i>Options:</i> <ul style="list-style-type: none"> <li>• Minimum and maximum limitation of the supply air temperature</li> <li>• Outside temperature-dependent functions</li> <li>• Anti-icing protection for heat recovery</li> <li>• Comfort / Economy changeover</li> <li>• Comfort / Protection Mode changeover (time switch)</li> </ul>	
RLU232 A09	<b>AECF04 LU3 HQ</b> Supply air temperature control with heat recovery, hot water heating coil, frost protection, chilled water cooling coil and fan release. <i>Options:</i> <ul style="list-style-type: none"> <li>• Room temperature cascade control</li> <li>• Outside temperature-dependent functions</li> <li>• Anti-icing protection for heat recovery</li> <li>• Comfort / Economy changeover</li> <li>• Comfort / Protection Mode changeover (time switch)</li> </ul>	
RLU232 A10	<b>ADC009 LU3 HQ</b> Extract air (room) temperature control with hot water heating coil and 2 chilled water cooling coils. <i>Options:</i> <ul style="list-style-type: none"> <li>• Minimum and maximum limitation of the supply air temperature</li> <li>• Outside temperature-dependent functions</li> <li>• Remote setpoint readjuster</li> <li>• Comfort / Economy changeover</li> <li>• Comfort / Protection Mode changeover (time switch)</li> </ul>	
RLU232 A11	<b>ADC018 LU3 HQ</b> Supply air temperature control with hot water heating coil and 2 chilled water cooling coils. <i>Options:</i> <ul style="list-style-type: none"> <li>• Room temperature cascade control</li> <li>• Outside temperature-dependent functions</li> <li>• Remote setpoint readjuster</li> <li>• Comfort / Economy changeover</li> <li>• Comfort / Protection Mode changeover (time switch)</li> </ul>	
RLU232 A12	<b>AEDK01 LU3 HQ</b> Supply air temperature control and room humidity control (r.h.) with heat recovery, hot water heating coil and spray humidifier. <i>Options:</i> <ul style="list-style-type: none"> <li>• Room temperature cascade control</li> <li>• Maximum limitation of the supply air humidity</li> <li>• Outside temperature-dependent functions</li> <li>• Comfort / Economy changeover</li> <li>• Comfort / Protection Mode changeover (time switch)</li> </ul>	

Controller- / basic type	Application no. / description	Plant diagram / connection diagram
RLU232 A13	<b>ADE001 LU3 HQ</b> Extract air (room) temperature control and dewpoint control with hot water preheating coil, frost protection, chilled water cooling coil, hot water reheating coil and fan release. <i>Options:</i> <ul style="list-style-type: none"> <li>• Minimum and maximum limitation of the supply air temperature</li> <li>• Outside temperature-dependent functions</li> <li>• Comfort / Economy changeover</li> <li>• Comfort / Protection Mode changeover (time switch)</li> </ul>	
RLU232 A14	<b>ADFA01 LU3 HQ</b> Supply air temperature and extract air (room) humidity control (r.h.) with hot water heating coil, frost protection, spray humidifier, chilled water cooling coil and fan release. <i>Options:</i> <ul style="list-style-type: none"> <li>• Maximum limitation of the supply air humidity</li> <li>• Outside temperature-dependent functions</li> <li>• Comfort / Economy changeover</li> <li>• Comfort / Protection Mode changeover (time switch)</li> </ul>	
RLU232 A15	<b>ADFA02 LU3 HQ</b> Extract air (room) temperature control and dew point control with hot water preheating coil, frost protection, spray humidifier, chilled water cooling coil, hot water reheating coil and fan release. <i>Options:</i> <ul style="list-style-type: none"> <li>• Minimum and maximum limitation of the supply air temperature</li> <li>• Additional maximum selection from internal and external signal</li> <li>• Comfort / Economy changeover</li> <li>• Comfort / Protection Mode changeover (time switch)</li> </ul>	
RLU232 A16	<b>AEFH01 LU3 HQ</b> Supply air temperature and room humidity control (r.h.) with mixed air dampers, hot water heating coil, frost protection, chilled water cooling coil, spray humidifier and fan release. <i>Options:</i> <ul style="list-style-type: none"> <li>• Room temperature cascade control</li> <li>• Outside temperature-dependent functions</li> <li>• Comfort / Economy changeover</li> <li>• Comfort / Protection Mode changeover (time switch)</li> </ul>	
RLU232 A17	<b>AECD01 LU3 HQ</b> Extract air (room) temperature control and mixed air temperature control <i>Options:</i> <ul style="list-style-type: none"> <li>• Minimum and maximum limitation of supply air temperature</li> <li>• Outside temperature-dependent functions</li> <li>• Comfort / Economy changeover</li> <li>• Comfort / Protection Mode changeover (time switch)</li> </ul>	
RLU232 U01	<b>ABA001 LU3 HQ</b> 2 independent supply air temperature control systems with hot water heating coils. <i>Options:</i> <ul style="list-style-type: none"> <li>• 2 independent remote setpoint adjusters</li> <li>• Outside temperature-dependent functions</li> <li>• Comfort / Protection Mode changeover (time switch)</li> </ul>	
RLU232 U02	<b>ADL001 LU3 HQ</b> Supply and extract air volume control with fan control. <i>Options:</i> <ul style="list-style-type: none"> <li>• 2 independent remote setpoint adjusters</li> <li>• Outside temperature-dependent functions</li> <li>• Comfort / Protection Mode changeover (time switch)</li> </ul>	

Controller- / basic type	Application no. / description	Plant diagram / connection diagram
RLU232 U03	ZZZ003 LU3 HQ Linear 2-step switch	
RLU232 U04	ZZZ004 LU3 HQ Binary 2-step switch	
RLU232 U05	ZZZ005 LU3 HQ Variable 2-step switch	
RLU236 A01	<b>ADA007 LU3 HQ</b> Extract air (room) temperature control with electric air heater battery. <i>Options:</i> <ul style="list-style-type: none"> <li>• Min. and max. limitation of the supply air temperature</li> <li>• Outside temperature-dependent functions</li> <li>• Remote setpoint readjuster</li> <li>• 6-stage electric air heater battery</li> <li>• Comfort / Economy changeover</li> <li>• Comfort / Protection Mode changeover (time switch)</li> </ul>	
RLU236 A02	<b>ADA013 LU3 HQ</b> Supply air temperature control with electric air heater battery. <i>Options:</i> <ul style="list-style-type: none"> <li>• Room temperature cascade control</li> <li>• Outside temperature-dependent functions</li> <li>• Remote setpoint readjuster</li> <li>• 6-stage electric air heater battery</li> <li>• Comfort / Economy changeover</li> <li>• Comfort / Protection Mode changeover (time switch)</li> </ul>	
RLU236 A03	<b>ADB004 LU3 HQ</b> Extract air (room) temperature control with DX cooler battery. <i>Options:</i> <ul style="list-style-type: none"> <li>• Min. and max. limitation of the supply air temperature</li> <li>• Outside temperature-dependent functions</li> <li>• Remote setpoint readjuster</li> <li>• 6-stage dx cooler battery</li> <li>• Comfort / Economy changeover</li> <li>• Comfort / Protection Mode changeover (time switch)</li> </ul>	
RLU236 A04	<b>ADB008 LU3 HQ</b> Supply air temperature control with DX cooler battery. <i>Options:</i> <ul style="list-style-type: none"> <li>• Room temperature cascade control</li> <li>• Outside temperature-dependent functions</li> <li>• Remote setpoint readjuster</li> <li>• 6-stage DX cooler battery</li> <li>• Comfort / Economy changeover</li> <li>• Comfort / Protection Mode changeover (time switch)</li> </ul>	

Controller- / basic type	Application no. / description	Plant diagram / connection diagram
RLU236 A05	<b>ADC005 LU3 HQ</b> Extract air (room) temperature control with electric air heater battery and DX cooler battery. <i>Options:</i> <ul style="list-style-type: none"> <li>• Minimum and maximum limitation of the supply air temperature</li> <li>• Outside temperature-dependent functions</li> <li>• Remote setpoint readjuster</li> <li>• 4-stage electric air heater battery</li> <li>• 2-stage DX cooler battery</li> <li>• Comfort / Economy changeover</li> <li>• Comfort / Protection Mode changeover (time switch)</li> </ul>	
RLU236 A06	<b>ADC013 LU3 HQ</b> Supply air temperature control with electric air heater battery and DX cooler battery. <i>Options:</i> <ul style="list-style-type: none"> <li>• Room temperature cascade control</li> <li>• Outside temperature-dependent functions</li> <li>• Remote setpoint readjuster</li> <li>• 4-stage electric air heater battery</li> <li>• 2-stage DX cooler battery</li> <li>• Comfort / Economy changeover</li> <li>• Comfort / Protection Mode changeover (time switch)</li> </ul>	
RLU236 A07	<b>ADC008 LU3 HQ</b> Extract air (room) temperature control with hot water air heating coil, frost protection, DX cooler battery and fan release. <i>Options:</i> <ul style="list-style-type: none"> <li>• Minimum and maximum limitation of the supply air temperature</li> <li>• Outside temperature-dependent functions</li> <li>• Remote setpoint readjuster</li> <li>• 4-stage DX cooler battery</li> <li>• Comfort / Economy changeover</li> <li>• Comfort / Protection Mode changeover (time switch)</li> </ul>	
RLU236 A08	<b>ADC017 LU3 HQ</b> Supply air temperature control with hot water heating coil, frost protection, DX cooler battery and fan release. <i>Options:</i> <ul style="list-style-type: none"> <li>• Room temperature cascade control</li> <li>• Outside temperature-dependent functions</li> <li>• Remote setpoint readjuster</li> <li>• 4-stage DX cooler battery</li> <li>• Comfort / Economy changeover</li> <li>• Comfort / Protection Mode changeover (time switch)</li> </ul>	
RLU236 A09	<b>AEDL01 LU3 HQ</b> Supply air temperature and supply air humidity control (r.h.) with closed-circuit heat recovery system, hot water heating coil, frost protection, spray humidifier and fan release. <i>Options:</i> <ul style="list-style-type: none"> <li>• Room temperature cascade control</li> <li>• Outside temperature-dependent functions</li> <li>• Comfort / Economy changeover</li> <li>• Comfort / Protection Mode changeover (time switch)</li> </ul>	
RLU236 A10	<b>AEFL01 LU3 HQ</b> Supply air temperature and supply air humidity control (r.h.) with closed-circuit heat recovery system, DX cooler battery, hot water heating coil, frost protection, spray humidifier and fan release. <i>Options:</i> <ul style="list-style-type: none"> <li>• Room temperature cascade control</li> <li>• Outside temperature-dependent functions</li> <li>• 2-stage DX cooler battery</li> <li>• Comfort / Economy changeover</li> <li>• Comfort / Protection Mode changeover (time switch)</li> </ul>	

Controller- / basic type	Application no. / description	Plant diagram / connection diagram
RLU236 A11	<b>AECD02 LU3 HQ</b> Extract air (room) temperature control and mixed air temperature control <i>Options:</i> <ul style="list-style-type: none"> <li>• Minimum and maximum limitation of supply air temperature</li> <li>• Outside temperature-dependent functions</li> <li>• Remote setpoint readjuster</li> <li>• 2-stage electric air heater battery</li> <li>• 2-stage direct expansion cooler battery</li> <li>• Comfort / Economy changeover</li> <li>• Comfort / Protection Mode changeover (time switch)</li> </ul>	
RLU236 A12	<b>AEZD01 LU3 HQ</b> Extract air (room) temperature and mixed air temperature control and supply air differential pressure control <i>Options:</i> <ul style="list-style-type: none"> <li>• Minimum and maximum limitation of supply air temperature</li> <li>• Outside temperature-dependent functions</li> <li>• 2-stage electric air heater battery</li> <li>• 2-stage direct expansion cooler battery</li> <li>• Comfort / Economy changeover</li> <li>• Comfort / Protection Mode changeover (time switch)</li> </ul>	
RLU236 A13	<b>AEGD01 LU3 HQ</b> Extract air (room) temperature and mixed air temperature control and humidity control <i>Options:</i> <ul style="list-style-type: none"> <li>• Minimum and maximum limitation of supply air temperature</li> <li>• Outside temperature-dependent functions</li> <li>• 2-stage electric air heater battery</li> <li>• 2-stage direct expansion cooler battery</li> <li>• Comfort / Economy changeover</li> <li>• Comfort / Protection Mode changeover (time switch)</li> </ul>	
RLU236 A14	<b>AECD03 LU3 HQ</b> Supply air temperature control <i>Options:</i> <ul style="list-style-type: none"> <li>• Room temperature cascade control</li> <li>• Outside temperature-dependent functions</li> <li>• Remote setpoint readjuster</li> <li>• 4-stage electric air heater battery</li> <li>• 2-stage direct expansion cooler battery</li> <li>• Comfort / Economy changeover</li> <li>• Comfort / Protection Mode changeover (time switch)</li> </ul>	
RLU236 U01	<b>ADKA03 LU3 HQ</b> Extract air (room) humidity control (r.h.) with spray humidifier. <i>Options:</i> <ul style="list-style-type: none"> <li>• Maximum limitation of the supply air humidity</li> <li>• Outside temperature-dependent functions</li> <li>• Remote setpoint adjuster</li> <li>• 6-stage spray humidifier</li> <li>• Comfort / Economy changeover</li> <li>• Comfort / Protection Mode changeover (time switch)</li> </ul>	
RLU236 U02	<b>PB0003 LU3 HQ</b> Differential pressure control of water with load-dependent pump control. <i>Options:</i> <ul style="list-style-type: none"> <li>• Minimum and maximum pressure limit controller</li> <li>• Outside temperature-dependent functions</li> <li>• Remote setpoint adjuster</li> <li>• Comfort / Economy changeover</li> <li>• Comfort / Protection Mode changeover (time switch)</li> </ul>	

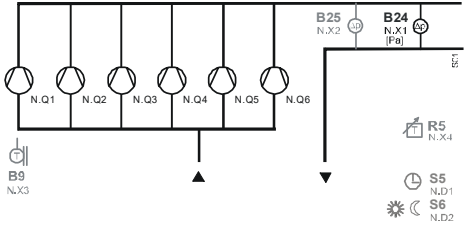
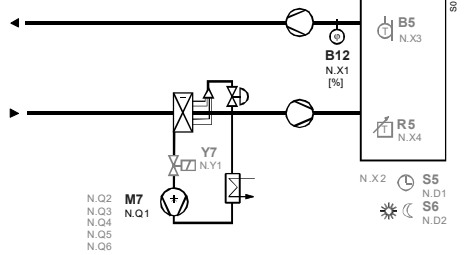
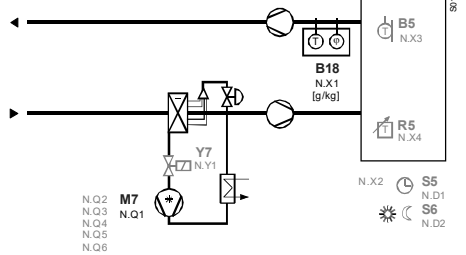
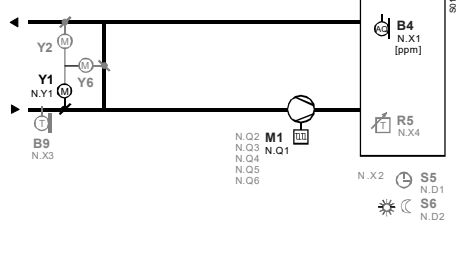
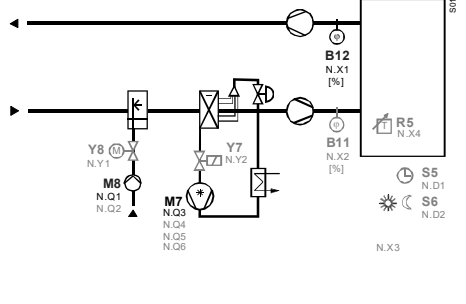
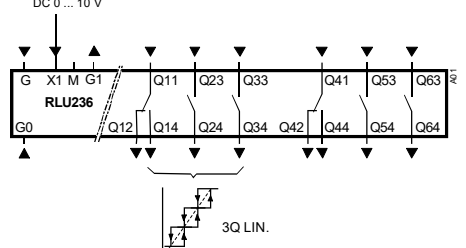
Controller- / basic type	Application no. / description	Plant diagram / connection diagram
RLU236 U03	<b>AZL003 LU3 HQ</b> Differential pressure control of air with load-dependent fan control. <i>Options:</i> <ul style="list-style-type: none"> <li>• Minimum and maximum pressure limit controller</li> <li>• Outside temperature-dependent functions</li> <li>• Remote setpoint adjuster</li> <li>• Comfort / Economy changeover</li> <li>• Comfort / Protection Mode changeover (time switch)</li> </ul>	
RLU236 U04	<b>ADI004 LU3 HQ</b> Extract air (room) humidity control (r.h.) with DX cooler battery. <i>Options:</i> <ul style="list-style-type: none"> <li>• Additional maximum selection from internal and external signal</li> <li>• Room temperature-dependent shifting of humidity setpoint</li> <li>• Remote setpoint adjuster</li> <li>• 6-stage DX cooler battery</li> <li>• Comfort / Economy changeover</li> <li>• Comfort / Protection Mode changeover (time switch)</li> </ul>	
RLU236 U05	<b>ADI006 LU3 HQ</b> Extract air (room) humidity control (a.h.) with DX cooler battery. <i>Options:</i> <ul style="list-style-type: none"> <li>• Additional maximum selection from internal and external signal</li> <li>• Room temperature-dependent shifting of humidity setpoint</li> <li>• Remote setpoint adjuster</li> <li>• 6-stage DX cooler battery</li> <li>• Comfort / Economy changeover</li> <li>• Comfort / Protection Mode changeover (time switch)</li> </ul>	
RLU236 U06	<b>AAZD03 LU3 HQ</b> Indoor air quality control with mixed air dampers and fan control. <i>Options:</i> <ul style="list-style-type: none"> <li>• Additional maximum selection from internal and external signal</li> <li>• Outside temperature-dependent functions</li> <li>• Remote setpoint adjuster</li> <li>• 6-speed fan</li> <li>• Comfort / Economy changeover</li> <li>• Comfort / Protection Mode changeover (time switch)</li> </ul>	
RLU236 U07	<b>ADZA02 LU3 HQ</b> Extract air (room) humidity control (r.h.) with spray humidifier and DX cooler battery. <i>Options:</i> <ul style="list-style-type: none"> <li>• Maximum limitation of supply air humidity</li> <li>• Additional maximum selection from internal and external signal</li> <li>• Remote setpoint adjuster</li> <li>• 2-stage spray humidifier</li> <li>• 4-stage DX cooler battery</li> <li>• Comfort / Economy changeover</li> <li>• Comfort / Protection Mode changeover (time switch)</li> </ul>	
RLU236 U08	<b>ZZZ006 LU3 HQ</b> Linear 3-step switch	



Controller- / basic type	Application no. / description	Plant diagram / connection diagram
RLU236 U09	ZZZ007 LU3 HQ Linear 4-step switch	
RLU236 U10	ZZZ008 LU3 HQ Linear 5-step switch	
RLU236 U11	ZZZ009 LU3 HQ Linear 6-step switch	
RLU236 U12	ZZZ010 LU3 HQ Variable 3-step switch	
RLU236 U13	ZZZ011 LU3 HQ Variable 4-step switch	
RLU236 U14	ZZZ012 LU3 HQ Variable 5-step switch	

Controller- / basic type	Application no. / description	Plant diagram / connection diagram
RLU236 U15	ZZZ013 LU3 HQ Variable 6-step switch	
RLU236 U16	ZZZ014 LU3 HQ Binary step switch with 7 steps (3 relays)	
RLU236 U17	ZZZ015 LU3 HQ Binary step switch with 15 steps (4 relays)	
RLU236 U18	CZZ001 LU3 HQ Condensation pressure control <i>Options:</i> • Switching via external time switch	

Dimensions (dimensions in mm)

RLU202, RLU220,  
RLU222

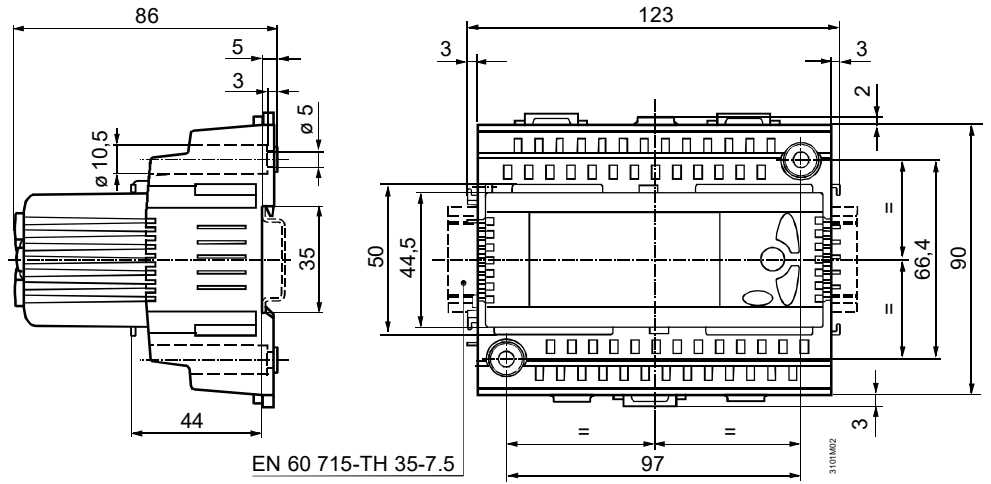

RLU232, RLU236

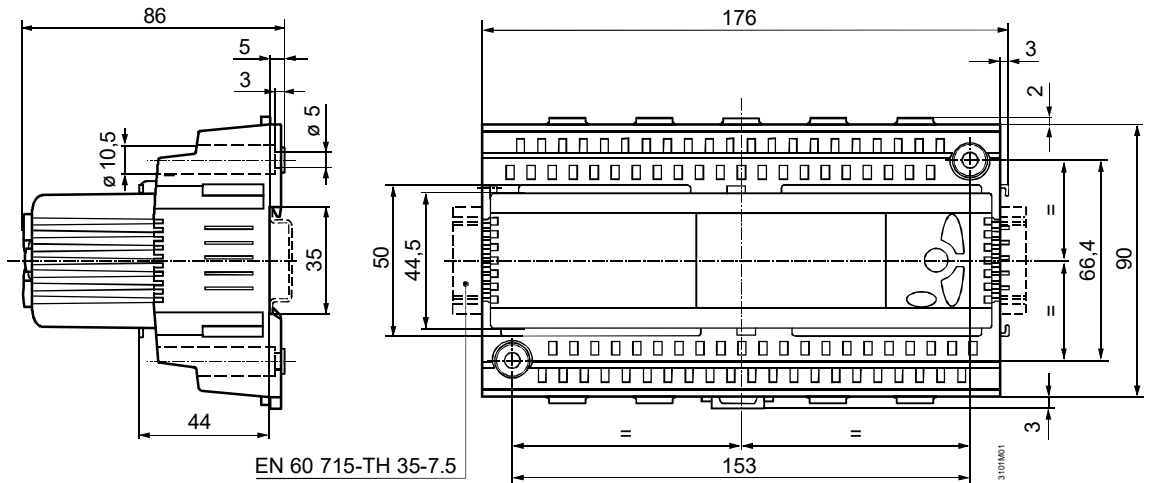

**ARG62.201**

Mounting frame for **RLU202, RLU220**  
and **RLU222**:

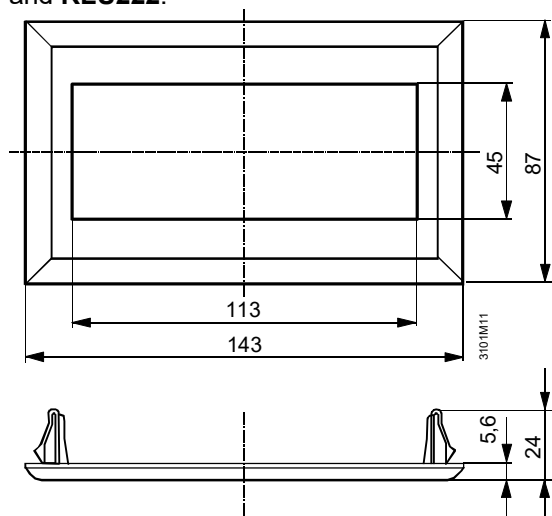

Mounting frame for **RLU232** and **RLU236**:

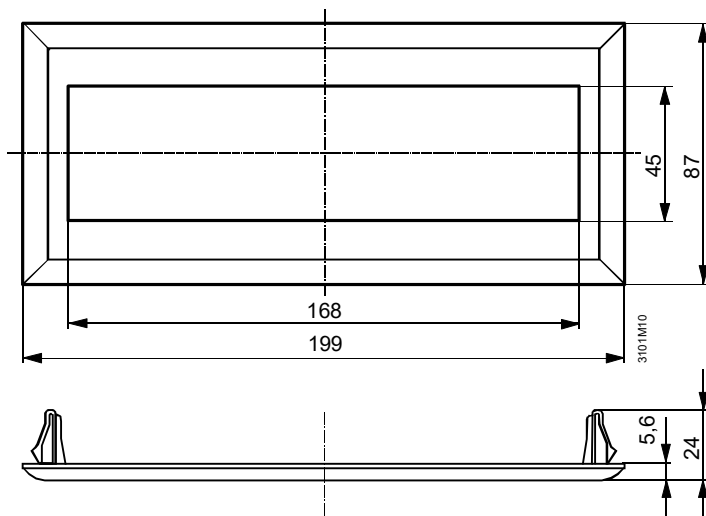

Panel cutout if controller shall be wired prior to mounting:

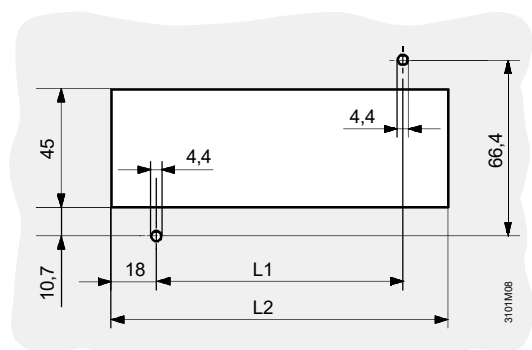

Type	L1	L2
<b>RLU202, RLU220, RLU222</b>	97	133
<b>RLU232, RLU236</b>	153	189

Panel cutout if controller shall be wired after mounting:

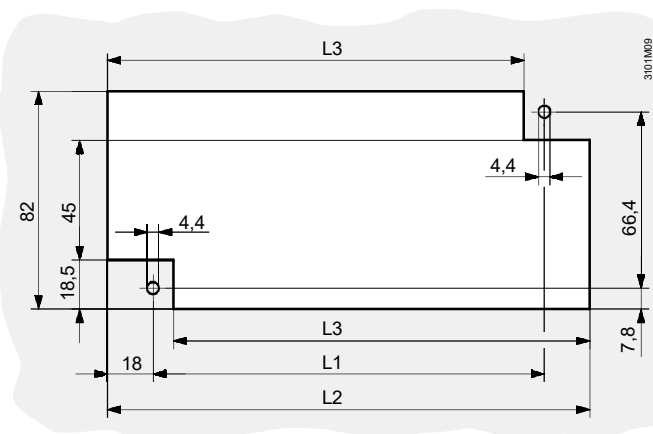

Type	L1	L2	L3
<b>RLU202, RLU220, RLU222</b>	97	133	107
<b>RLU232, RLU236</b>	153	189	163

Published by:  
Siemens Switzerland Ltd.  
Smart Infrastructure  
Global Headquarters  
Theilerstrasse 1a  
CH-6300 Zug  
Switzerland  
Tel. +41 58-724 24 24  
[www.siemens.com/buildingtechnologies](http://www.siemens.com/buildingtechnologies)

© Siemens Switzerland Ltd 2000  
Delivery and technical specifications subject to change